

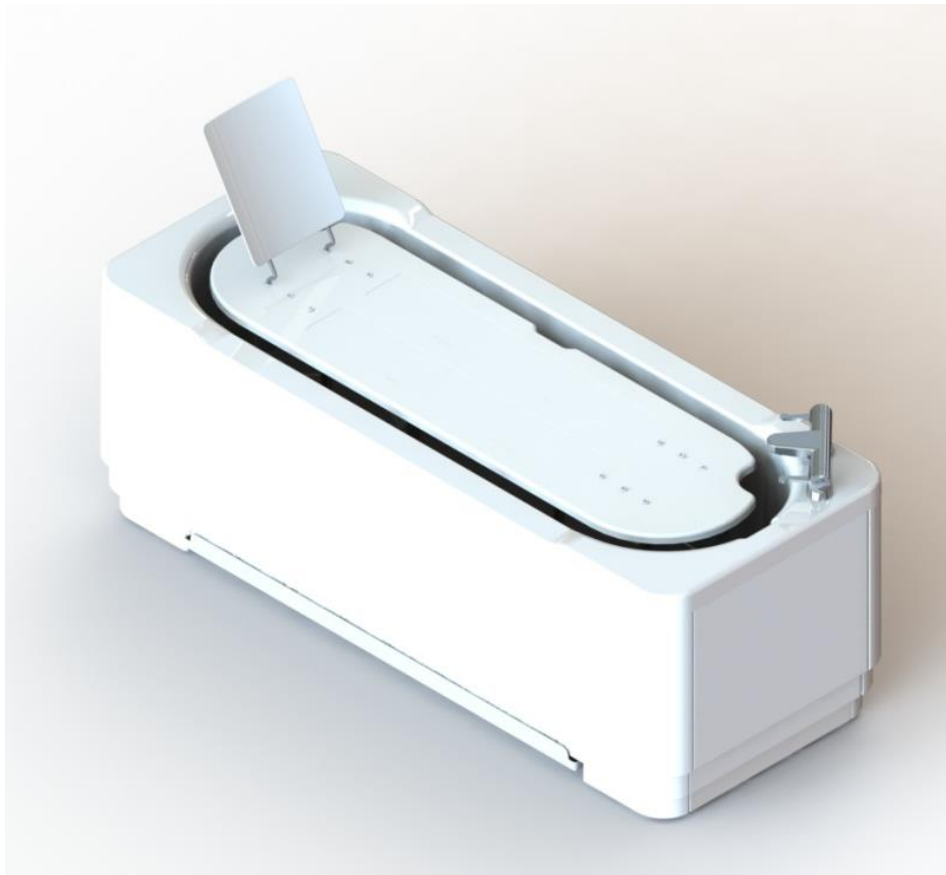

ABACUS

SPECIALIST BATHROOM SOLUTIONS

GEMINI 2000 USER MANUAL



Gainsborough Healthcare Group

Life enhancing bathing



Tel: 01527 400024

Email: info@abacushealthcare.co.uk

www.abacushealthcare.co.uk

Technical Specification (Dimensions in mm)

| | |
|---------------------------------|--------------------------------|
| Maximum dimensions (W x H x L) | 800 x 1396 x 2000 |
| Minimum dimensions (W x H x L) | 800 x 674 x 2000 |
| Internal dimensions (W x H x L) | 575 x 525 x 1756 |
| Bath capacity | 350L |
| Bath weight (empty) | 240kg |
| Platform (W x L) | 490 x 1700 |
| Fill time | 6 minutes 20 seconds |
| Power supply | 24 Volt DC battery/transformer |
| Maximum user weight | 165kg |

Dimensions

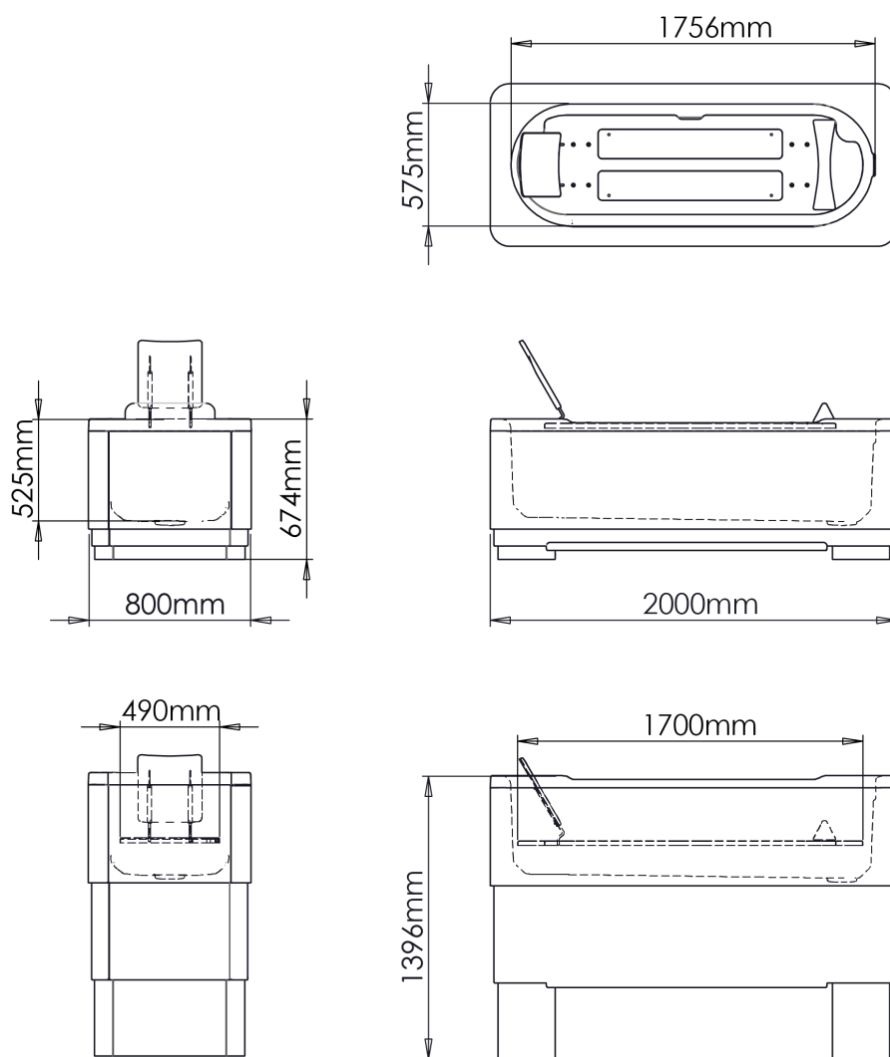

Figure I.0

Warranty

Our bath products are guaranteed for a period of twelve months from the date of delivery. All parts are covered against defects that may arise as the result of faulty materials, inferior workmanship or construction.

The baths are not covered for any problems that may arise from the installation or site planning unless carried out by engineers from Abacus Healthcare.

Any consequence arising from unskilled or incorrect handling of the product is not covered by this guarantee.

The following items, when supplied by Abacus Healthcare are guaranteed for a period of twelve months from the date of supply for the parts only (labour costs are not covered).

- Taps and mixers
- Shower hoses, shower heads and shower brackets.
- Flexible pipes including waste outlet, hot and cold supply.

Hot and cold taps and mixer taps are proprietary fittings and as such carry a standard manufacturer's warranty.

Note: Thermostatic mixing valves must be adjusted for the appropriate discharge temperature by the installer. These require regular maintenance for which Abacus engineers are available.

- Electrical

All electrical components fitted to Abacus baths are CE marked to comply with current European Standards.

Electrical items must not be replaced with alternative components without the authorisation of Abacus Healthcare.

Failure to obtain such authorisation will exempt the Company from any liability to action for further failure.

Safety Instructions

Always ensure the equipment is operated by trained staff.

Always ensure the mains electricity is switched on.

Always keep users hands away from moving parts.

Always ensure that the bather's hands and feet are kept away from the cut outs in the platform.

Always check the position of the bather on the platform before raising/lowering the bath.

Always have the equipment serviced regularly (see Service Level Agreement).

Always ensure the shower head is returned to its holder when not in use.

Never use the bath for any purpose other than that for which it has been designed.

Never leave the bath with the platform in a raised position.

Never allow other equipment such as hoists to contact the bath forcibly as this may cause damage.

Never allow items such as the shower head to remain beneath the platform when raising the bath.

Regularly clean the bath using non-abrasive cleaners.

Always fit the headrest

In instances where access is required to the underside of the bath platform, always remove platform accessories (i.e. headrest, footrest) prior to manually lifting bath platform.

Where access to the underside of the platform is required, always ensure the platform is in its highest position prior to manually lifting the platform.

When filling the bath, only fill to the halfway point prior to introducing the bather. Once the bather is comfortably seated top up the bath if required.

Maintenance

After each use: Dissolve a sterilising tablet into the bath water and then run the system prior to sending the water to waste

Clean the bath and fittings using a soft cloth and non abrasive cleaner with anti-bacterial agent.

Monthly: Test RCDs.

Annually: Servicing by an approved company in accordance with the manufacturer's instructions.

Notices

WARNING!

The system batteries must be charged for 24 hours prior to using the bath. You may test the bath to ensure it is working correctly.

Ensure that hands and objects are kept away from the underside and topside when operating the bath.

Ensure that the floor area around the bath is kept free from excess water to avoid slipping hazards.

Do not allow unauthorised persons to operate the bathing system.

This bath moves. Ensure that there are no objects or persons that can become trapped or injured while the bath seat is raised or lowered.

If this unit is to be utilised by many different bathers, we would strongly recommend that it is cleaned regularly with a medical disinfectant, as well as following a strict cleaning routine.

In the event of mains failure during use of the bath, back-up batteries will enable the bather to exit the bath. The bath will be disabled until mains power is restored.

Never leave the bather unattended. Always ensure that the bather's hands and feet are kept away from any gaps around the seat.

Ensure that the shower head is always returned to its holder after use.

Ensure that the handset is always returned to its holder after use.

Never use the bath other than for its intended function.

Never leave the seat in either the raised position or outside of the bath. Always leave it in the down position inside the bath.

WARNING: Risk of electric shock; do not allow electrical appliances within 1.5m of the bath.

WARNING: Ensure hands and objects are kept away from the underside of the seat and bath when in operation.



OPERATION INSTRUCTIONS

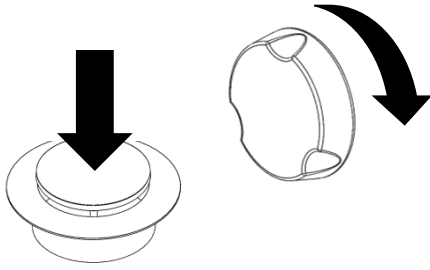

Fig 1

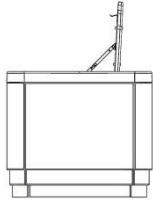

Fig 2

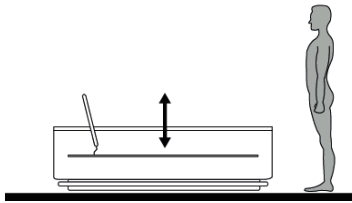

Fig 3

1. To close the pop up waste rotate the chrome turn handle clockwise until the waste plug locates in the outlet (fig 1).

2. Fill the bath with water to your requirement level. The platform may be lifted to observe the depth of water (fig 2).

Check the temperature of the water.

3. Set the bath and platform level at the height appropriate for transfer of the bather (as low as possible for an ambulant transfer or raised to allow access for a portable hoist) (fig 3)

4. Allow/assist the bather to transfer onto the platform (a bed type transfer for an ambulant bather)(fig 4).

A: Ambulant



B: Ceiling track hoist

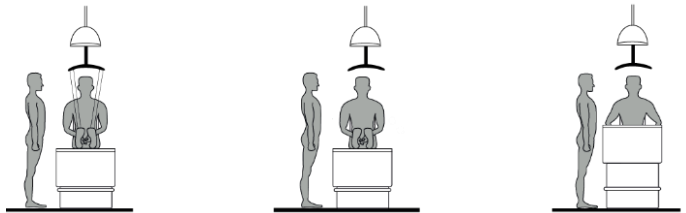

Fig 4

C: Mobile/portable hoist



D: Wheelchair



HANDSET INSTRUCTIONS



Fig 1

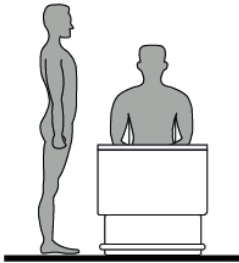

Fig 2

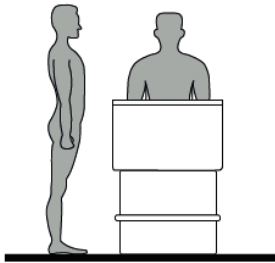

Fig 3

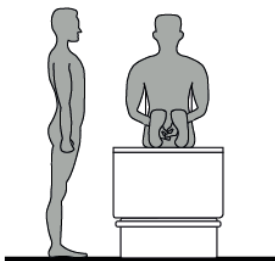
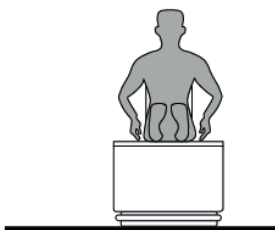

Fig 4



1. With the bather seated, raise the bath around the platform and bather (fig 1), by pressing and holding the platform up icon.

The bather will now be immersed in water.



2. Raise the bath and platform to the most comfortable height for the carer to provide assistance (fig 2), by pressing the bath up icon.



3. When bathing is completed, lower the bath full of water to below the level of the platform (fig 3), by pressing and holding the platform down icon.



The platform may be used for drying/dressing prior to transfer (or at anytime). The height of the platform may be adjusted to the optimum height for the carer by pressing and holding the bath down icon.



4. Assist to towel dry/dress the bather.

5. Lower the whole bath to the desired user transfer height (fig 4) for easy transfer (ambulant or hoist) by pressing and holding the bath down icon.



6. Allow/assist the bather to transfer off the platform (see transfers – figure 5.0 on page 6).

7. Empty the bath using the pop up waste by turning the handle anticlockwise.

8. Prepare the bath ready for the next bather (clean, disinfect etc).

HANDSET INSTRUCTIONS

Handset Lock

The bath features a handset lock. The lock gives the user the ability to fully lock the handset if desired.

Activating the handset lock will prevent any of the handset buttons being used.

1. To activate the handset lock, press and hold the 'Bath Down' and 'Platform Down' buttons simultaneously.



The handset will emit one short beep, followed by a longer beep. This sound indicates that the handset is now locked.

Pressing any of the handset buttons will now emit a short beep, letting you know the handset is still locked.

2. To de-activate the handset, press and hold the 'Bath Down' and 'Platform Down' buttons simultaneously.

The handset will emit one short beep, followed by a longer beep. This sound indicates that the handset is now unlocked, and normal function may continue.

HEAD AND BACK REST

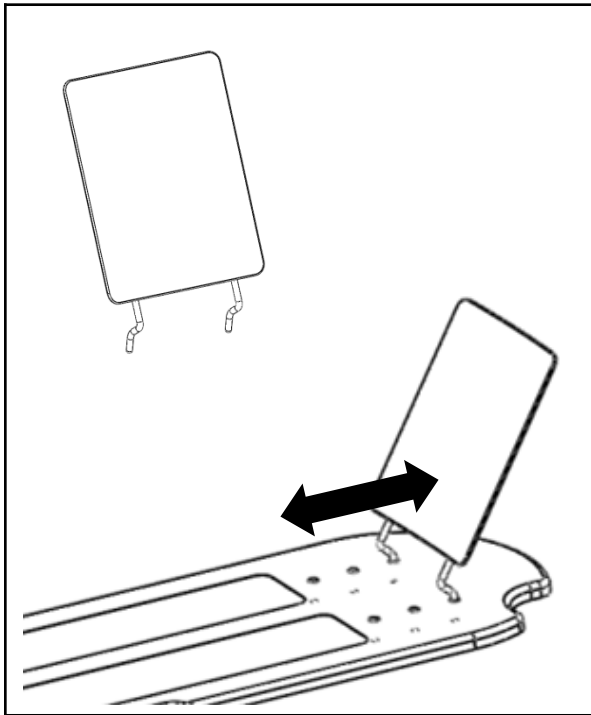

The bath comes complete with a removable high rise supportive backrest.

The backrest has been designed to offer a variation in position for the bather to suit a variety of user needs.

Use of the backrest is dependent on the individual user mobility and situation.

The backrest has three variable positions, adjustable for bather comfort and height.

Adjusting the backrest is simple, lift the backrest free of the platform and locate to a preferred position along the platform.

PLATFORM HINGE-STAY

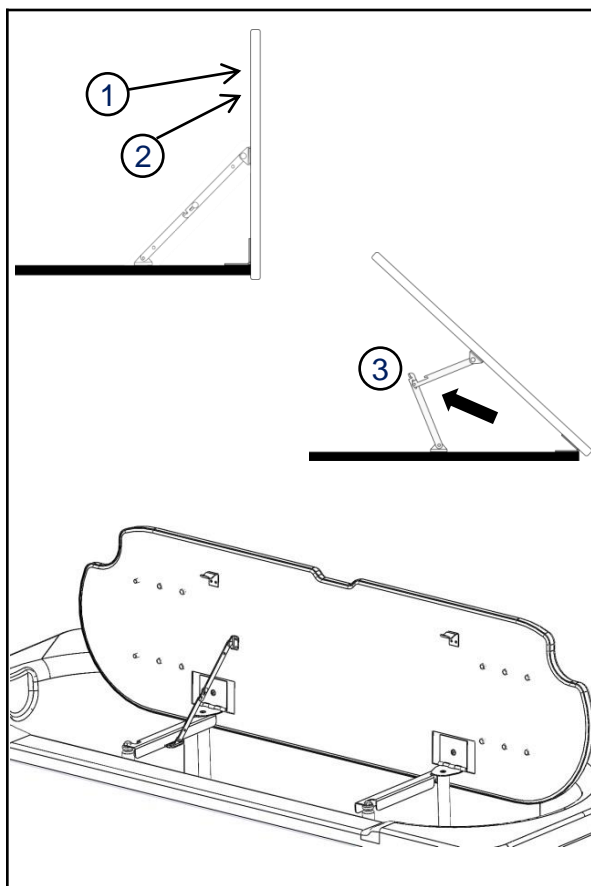

The bath Hinge-stay prevents the platform lowering once lifted to an upright position. (Back and footrest must be removed).

This safety feature enables the inside of the bath to be thoroughly cleaned without the need for the platform to be manually held up, leaving the cleaner to use both hands.

To open the platform:

1. Lift the platform to the fully open position and lower slightly (Hinge-stay will engage).

To close the platform:

2. Lift the platform the fully open position, immediately followed by step 3.
3. Fold out the Hinge-stay to disengage.

Slowly lower the platform to the horizontal position.

SAFE EDGE OBSTRUCTION SENSOR

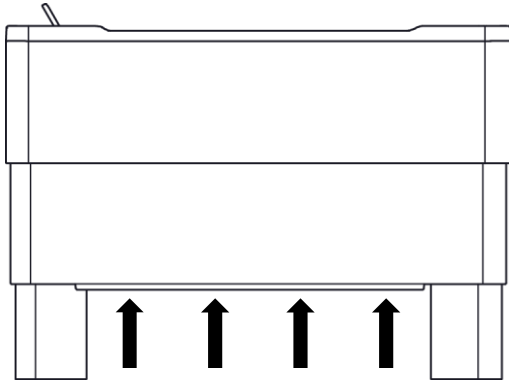

The underside of the bath is fitted with an obstruction sensor for added safety

Whilst in use, upward pressure on the underside of the bath will activate the sensor. Immediately stopping motion.

In the event of sensor activation, the bath can be raised as normal to allow the obstruction to be removed.

Normal use can now continue.

FOOTREST (OPTIONAL)

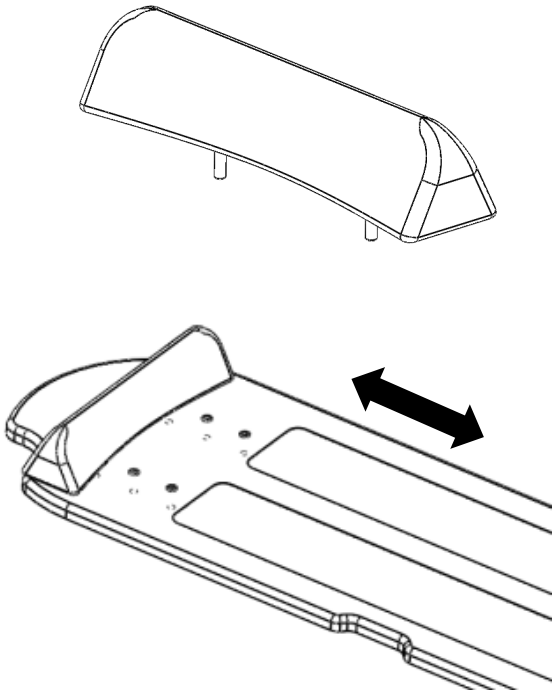

The bath footrest option can be used in conjunction with the supplied headrest to help support the bather in the desired position on the platform.

The footrest has three adjustable positions, and can be easily removed when not required.

Adjusting the footrest is simple, lift the footrest free of the platform and locate to a preferred position along the platform.

BIOCOTE

Abacus baths now feature integrated BioCote antimicrobial technology.

This silver-ion based technology has been proven to reduce harmful bacteria by up to 98% within care homes and hospitals. It continues to provide 99.9% 24/7 protection against harmful superbugs such as Influenza H1N1, E.coli, Salmonella and antibiotic resistant MRSA. This impressive capability is now supplied as standard in Abacus Gemini baths.

The hidden dangers of infectious Superbugs are a growing threat, particularly as traditional disinfectants are becoming ineffective against evolving microbes. When you consider vulnerable individuals can be more susceptible to infection, then the need for BioCote whilst bathing is vital. Reducing the risk of illness and cross contamination means less medical intervention is likely outside of the bathroom – reducing pressure and stress on everyone affected by disability.

Abacus believe in providing wellness with peace of mind so bathing is enjoyable and therapeutic.

BioCote is not a coating, it is integrated into GRP during the bath manufacture so cannot be wiped or worn away. Therefore, it provides consistent, infallible protection throughout the life time of the bath. This invisible component reduces stains, odours and enhances bath surface durability.



CHROMATHERAPY (OPTIONAL)



The Chromatherapy (colour therapy) option uses a range of lights to offer different mood effects as well as an automatic change over to slow auto-rotating spectrums of colour.

The colour therapy lights offer a choice of settings as detailed.

Colour options are as follows:

Green

Orange

Red

Violet

Blue

Yellow

Indigo

Rainbow Spectrum rotating lights

Off

Simply press to turn on.

Press again to change colour, repeat until desired colour is selected.

At any point hold down for 2 seconds to change to the auto rotating spectrum cycle.

The button is perfectly safe to use with wet hands.

AUTOFILL OPTION

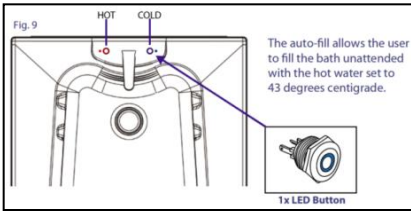

Fig 1

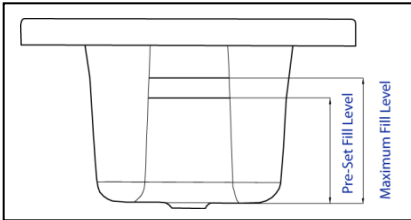

Fig 2



Fig 3

If the bath has the Autofill option, the bathing cycle can be completed without having to worry about overflowing. Simply press a button and the bath will fill automatically.

Filling the Bath

The autofill has two buttons for operation and one spout, the red button for hot water and the blue button for cold.

Press the red or blue fill button situated on the rim of the bath. **Fig 1.** The autofill buttons will glow on standby, and flash during filling.

This will fill the bath to a pre-set fill level. **Fig 2.**

Once the pre-set fill level is reached the water will automatically stop. If at any time you wish to stop the autofill process simply re-press the button.

The system allows you one additional top up past the pre-set fill level. Press the red or blue fill button; this will deliver water for a maximum of 30 seconds. Once again the flow can be stopped by re-pressing the button.

Temperature Adjustment

The red fill button supplies hot water at a pre-set temperature (usually 43°C). To reduce the temperature of the bath water during the autofill process, press the blue (cold) button. **Fig 1.**

When the bath filling is complete check the water temperature before the bather enters, or for 'walk-in baths' the user can stop, start or modify flow temperature as required throughout the autofill process.

Note – Once the maximum fill level has been reached, water must be drained before any more water can be added. **Fig 2.**

If you are unable to top up, drain water to below the pre-set fill level.

Tamperproof Lock Out - Fig 3.

The autofill has a lock out to prevent wastage of water and tampering.

To Lock

Press and hold down both hot and cold buttons for 10 seconds. The red and blue LED lights will go out, confirming water lock out.

To Unlock

Press and hold down both buttons again for 10 seconds. The buttons will turn red and blue confirming unlock.

For optimum performance it is recommended that the bath is cleaned regularly.

TESTING THE BATH

WARNING!

The system batteries must be charged for 24 hours prior to using the bath. You may test the bath to ensure it is working correctly.

Ensure that hands and objects are kept away from the underside and topside when operating the bath.

Ensure the floor area around the bath is kept free from excess water to avoid persons slipping.

Do not allow unauthorised persons to operate this bathing system.

This Bath moves. Ensure there are no objects or persons that can become trapped or injured while the bath raises or lowers.

BATH OPERATION

To operate the unit:

The handset control buttons are completely safe to use with wet hands, The up/down buttons operate independently on a 'depress-to-run' basis, in that movement will stop if the button is released.

Firstly, ensure that the platform is raised to the highest position using the platform DOWN button .

Lift the platform and check the pop up waste is in the fully closed position.

Next, make sure the bath is in the fully lowered position by pressing the bath DOWN button.

Fill the bath approximately half full with water. Check the water temperature is within safe bathing limits 40°- 43°.

Raise the bath using the bath UP button on the handset.

Empty the water whilst the bath is in the up position as this will help with the draining of the bath. Fully lower the bath using the bath DOWN button on the handset. Clean the bath as per the cleaning instructions. Ensure the Platform can easily be lifted by the front edge for cleaning underneath.

For finer details see 'Operating instructions' and 'Handset Instructions'

Where a safety lap belt is supplied this must be used for the safety of the bather.

WARNING! If this unit is to be utilised by many different bathers, we would strongly recommend that it is cleaned regularly with a medical disinfectant as well as following a strict cleaning routine.

WARNING

In the event of mains failure during use of the bath, back-up batteries will enable the bather to exit the bath. Do not carry on using until mains power is restored.

TROUBLE SHOOTING

*Some basic checks are detailed below.
If in doubt contact service support on 01527 400024.*

Bath Does not move

- Check power.
- Check fused spur to ensure there is power to the unit.
- Ensure the RCCB is working and has power to it. To test the RCCB push the test button; the RCCB should interrupt power and the switch should trip. Push the RESET button; power should be restored. If the RCCB fails to operate in this manner there is a problem with the electric supply and the service department should be contacted.

If mains power is interrupted the bath will only work on battery backup. The bath will continue to operate but as the batteries become low the bath will emit an audible beep when the handset is used.

Once the warning beep starts, lower the bath and do not use until the fault is rectified. Once power is restored allow the batteries to recharge before operation. (Usually 3 hours).

If the handset buttons do not work, but do however emit a short beep when pressed, the handset may be locked.

To unlock/ lock the handset see 'Handset Lock' section.

Bath judders.

- Usually occurs if the bath has not been fixed to the floor correctly or the bath is not level.

Bath noisy

- Check to ensure there is nothing touching the bath while it moves
- Ensure the pipe-work and cables are free of the panels and not rubbing against the framework
- Check panels are free to move and are not touching each other.

Bath Leaking

- Look for source of leak – typically caught flexi-hose on feed or waste. This can usually be remedied by your own maintenance contact.

Bath is uneven (*one end higher than the other*)

- This may occur after a power failure. Use the DOWN button on the handset. Lower the bath to its lowest position. This will automatically reset the bath so that both sides rise together.

Bath Beeping

- Mains power has failed to the unit – See section titled 'Bath does not move'

Bath Panels touching /noisy

- If the upper and lower panels touch, marking will occur. Adjust panels as necessary to correctly align.

CLEANING INFORMATION

The Gemini bath does not require any major maintenance, but you should follow these simple instructions. The bath should be wiped down, preferably whilst the bath is draining, with a soft, damp cloth. To retain the surface quality of the bath, clean weekly using bathroom cleaning mousse or washing-up liquid. Warm water and a soft cloth is recommended. Stubborn stains may require a non-scratch liquid cleaner.

Do not use oven cleaners, scouring powders or bleach on any of the surfaces. These may spoil the appearance of your bath.

Chalk mark deposits from the water or mild scratches may be removed from the bath surface with a mild cutting fluid such as 'T' Cut or Brasso. This should be applied to the affected area with a soft cloth and rubbed vigorously until a satisfactory finish is affected. The shine to the area may then be brought back using a wax-based polish.

Lift the platform and ensure that it is properly cleaned on its underside.

WARRANTY

This product is warranted as being free from defects during the period of warranty. This does not cover minor blemishes, etc. which may be part of normal manufacturing processes.

The warranty covers manufacturing defects in the products, starting from the date of supply. The warranty is limited to the value of the purchase price paid.

The warranty is only valid if the product has been used correctly. Where there are any mechanical or electrical parts, any damage, misuse or tampering with them will render the warranty invalid. Any sealed electrical boxes must remain unopened or this will invalidate any warranty.

The baths are not covered for any problems that may arise from the installation or site planning unless carried out by engineers from Abacus Healthcare.

Any consequence arising from unskilled or incorrect handling of the product is not covered by this guarantee.

The following items, when supplied by Abacus Healthcare are guaranteed for a period of twelve months from the date of supply for the parts only (labour costs are not covered).

- Taps and mixers
- Shower hoses, shower heads and shower brackets.
- Flexible pipes including waste outlet, hot and cold supply.

Hot and cold taps and mixer taps are proprietary fittings and as such carry a standard manufacturer's warranty.

Note: Thermostatic mixing valves must be adjusted for the appropriate discharge temperature by the installer. These require regular maintenance for which Abacus engineers are available.

• Electrical

All electrical components are CE marked to comply with current European Standards.

Electrical items must not be replaced with alternative components without the authorisation of Abacus Healthcare

Failure to obtain such authorisation will exempt the Company from any liability to action for further failure.

THERE IS NO OTHER WARRANTY EXPRESSED OR IMPLIED INCLUDING, BUT NOT LIMITED TO, THOSE OF MERCHANTABILITY AND FITNESS FOR A PARTICULAR PURPOSE.

THE FOREGOING WARRANTY IS LIMITED TO THE TIME PERIOD SPECIFIED FROM THE TIME OF RECEIPT. IN NO EVENT SHALL THE SUPPLIER BE LIABLE FOR ANY SPECIAL, INCIDENTAL, PUNITIVE, OR CONSEQUENTIAL DAMAGES INCLUDING BUT NOT LIMITED TO; LOSS OF USE. WHILE THIS WARRANTY GIVES YOU SPECIFIC LEGAL RIGHTS YOU MAY ALSO HAVE OTHER RIGHTS WHICH

THIS WARRANTY DOES NOT EXCLUDE YOU FROM.

GAINSBOROUGH HEALTHCARE GROUP. OPERATES A POLICY OF CONTINUOUS PRODUCT DEVELOPMENT AND RESERVES THE RIGHT TO CHANGE SPECIFICATIONS AND DESIGNS WITHOUT PRIOR NOTICE SO LONG AS THEY DO NOT MATERIALLY ALTER THE FUNCTION OF THE BATH.