



## DIGITAL MODULATING BOILERS

FOR HEATING AND SANITARY HOT WATER



CMX15  
CMX18



CM15  
CM18

INSTRUCCIONES DE INSTALACIÓN Y USO

INSTALLATION INSTRUCTIONS AND USER GUIDE

*Lea estas instrucciones atentamente antes de instalar o utilizar el aparato por primera vez.*

*Please read these instructions before installing or using this appliance for the first time.*

INDEX

<b>1 IMPORTANT</b> .....	18
<b>2 INSTALLATION</b> .....	19
<b>3 COMMISSIONING</b> .....	19
3.1 HEATING.....	19
3.2 SANITARY HOT WATER.....	20
<b>4 LIMITATION OF THE MAXIMUM OUTPUT</b> .....	20
<b>5 DESCRIPTION OF THE CONTROL PANEL</b> .....	22
<b>6 USING THE BOILER</b> .....	23
6.1 TURNING ON AND OFF.....	23
6.2 BLOCKING THE CONTROLS.....	23
6.3 HEATING.....	23
6.3.1 Ambient thermostat.....	24
6.3.2 Modulation of the heating.....	24
6.3.3 Anti-blocking of the accelerator pump.....	24
6.3.4 Heater safety.....	25
6.4 SANITARY HOT WATER.....	26
6.4.1 Adjusting the S.H.W. temperature.....	26
6.4.2 S.H.W. safety.....	26
<b>7 MAINTENANCE</b> .....	27
<b>8 TROUBLESHOOTING</b> .....	27
<b>9 TECHNICAL DATA</b> .....	28
<b>10 ENVIRONMENTAL INFORMATION</b> .....	29
<b>11 MAIN COMPONENTS</b> .....	29
<b>12 WIRING</b> .....	30

## 1 IMPORTANT

- The boiler's guarantee does not cover any damaged caused by the non-observance of any of these instructions.
- This manual must be conserved and given to any new user.
- This appliance is not destined for use by anyone (including children) with reduced physical, sensorial or mental capacities or those who do not know how to use the appliance, unless they are supervised or instructed by a person responsible for their safety.
- Check that the voltage on the indicator plate of the boiler coincides with the voltage of the mains circuit to which it is going to be connected.
- Any re-installation must be performed by qualified electricians.
- The use of these boilers in the presence of gases, explosives or inflammable objects is prohibited.
- The air inputs and outputs of the boiler ensure its correct operation and protect it from over-heating. They must never be covered.
- This boiler must be disconnected from the mains electricity before carrying out any internal repairs.
- The boiler must not be installed directly below a power take-off point.
- The boiler must be installed in such a manner that the switches or other controls cannot be touched by anyone who is using the bath or shower.
- The installation must be performed in accordance with current electricity regulations.
- This appliance is destined to be permanently connected to a fixed installation. The power circuit of the boiler must incorporate an omni-polar cut-off switch with a separation between the contacts of at least 3 mm.
- The electricity supply circuit must incorporate a differential switch.
- This boiler must be earthed.
- All the models incorporate different safety elements. If one or more of them are activated, consult the section PROBLEMS & SOLUTIONS.
- In time, the presence in the air of smoke, dust and pollution may stain the walls and areas close to the appliance.

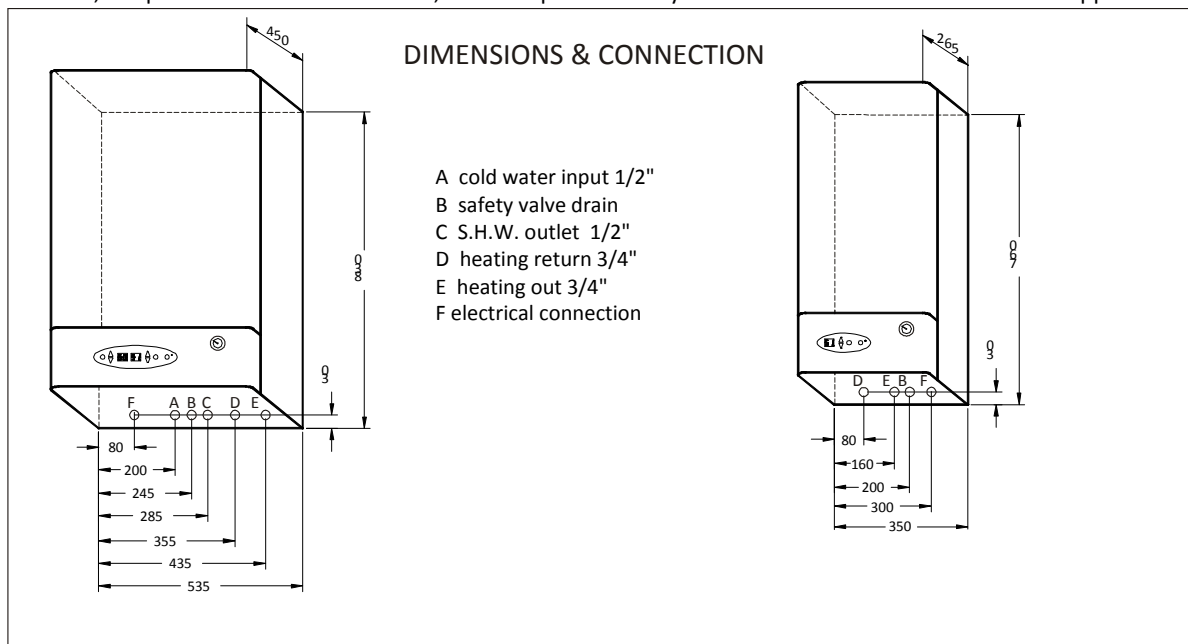

## UPS 25-40

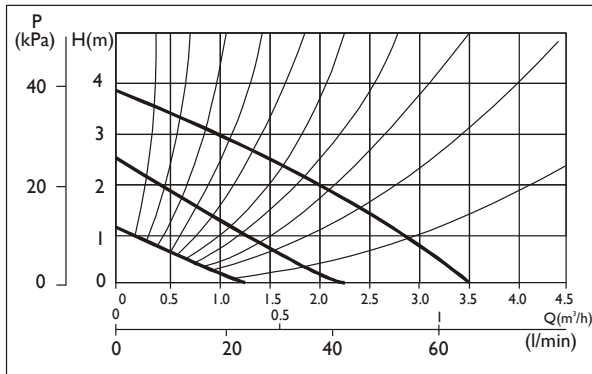

Working curves of the accelerator pump.

## 2 INSTALLATION

- Ensure that the mains voltage available coincides with that shown on the rating label.
- The electrical installation must comply with the current regulations. The cross-section of the power conductors must be sufficient for the rated power or the power to which the boiler has been limited.
- Install the necessary electrical protections as indicated in the current regulations. In the event of these regulations not being complied with, the manufacturer will not be liable for any bodily injury or material damage that may occur.
- It is necessary to install the boiler in such a manner that it can be separated from all the poles of the electricity mains with a contact clearance width of a minimum of 3 mm.
- The hydraulic connections to the heating and S.H.W. circuit must be carried out respecting the out and return marked on the boiler.
- Install purges in the radiators and high points of the installation.
- In models CM18 and CM15, install a filling valve for the heating circuit as close as possible to the boiler. In models CMX18 and CMX15, the filling valve is incorporated inside the boiler.
- Install the discharge valve at the lowest point of the installation, in order to be able to empty the installation completely if necessary.
- We recommend running the heating circuit pressure safety valve to the drain in order to avoid a water spillage in the event of the pressure exceeding 3 kg/cm<sup>2</sup>.
- CMX models only: It is essential to run the safety pressure valve of the S.H.W. header rated at 7 kg/cm<sup>2</sup> to a drain.
- If the circuit pressure exceeds 5 kg/cm<sup>2</sup>, it is recommended that a pressure reducer is installed in the pipe at the exit from the water meter of the dwelling.
- It is essential to connect the boiler to a good earth connection.
- The boiler can be controlled by an external regulator, for example an ambient thermostat or an ambient chrono-thermostat. This must be connected to the terminals on the electronic board once the existing bridge between both terminals has been suppressed. (See the electrical diagram). The use of an external regulator is essential for the modulating system to work.
- The installation must be performed in such a manner as to facilitate maintenance and repair work. The hydraulic connections must be made using flexible couplings or hoses in order to facilitate disconnecting the boiler from the circuit. If these aspects of the installation are not adhered to, the Technical Service will not be obliged to repair the boiler.
- Before carrying out any work inside the boiler, do not forget to disconnect the electrical supply.
- This boiler is not designed to be installed in the open air.
- If the heating installation includes hydraulic thermostatic valves or automatic area controls, it is necessary to avoid at all times interrupting the water circulation, as this will activate the safety thermostat.

## 3 COMMISSIONING

### 3.1 HEATING

Check that the drainage points located in the lower part of the installation are completely closed.

Open the purges of the installation and the boiler.

Open the filling valve until the water pressure gauge reads between approximately 1 and 1.5 bar.

Close the installation purges when water begins to flow through them. The boiler purge must not be closed.

Start the heating by pushing the  button the heating display will light up.

Select a set point higher than the temperature indicated on the heating display and check the consumption once the operating indicator of the central heating resistances lights up. The S.H.W. has priority; if the S.H.W. is connected and consuming, this point cannot be verified.

Purge the installation again if necessary.

Reinstate any possible losses in pressure by opening the filling valve until the pressure gauge reads between 1 and 1.5 bar.

If the boiler includes the option of radiant floor heating (requested on placing the order), the central heating safety thermostat will activate at 80°C and the temperature of the heating resistance cannot exceed 50°C.

### 3.2 SANITARY HOT WATER (S.H.W.)

**Proceed to fill the 50-litre accumulator tank, opening the tap of the S.H.W. to draw out the air from the water accumulator.**

Once the water is flowing normally, shut off the tap and connect the S.H.W. by pushing the  button. Select a resistance temperature for the S.H.W. higher than the temperature shown on the S.H.W. display and check that the consumption indicator of the S.H.W. resistances lights up.

Check that once the set point temperature has been reached, the consumption indicator goes off.

If at this moment a hot water tap is opened with a minimum flow, the consumption indicator will light up again immediately thanks to the flow detection system. The set point will move 3°C higher than that selected during a connection/disconnection cycle. This will supply more hot water as it will eliminate the dead time of the resistance connection due to the lowering of the temperature in the tank.

## **4 LIMITATION OF THE MAXIMUM OUTPUT**

It is possible to limit the maximum output of the boilers by selecting the combination required in the table corresponding to each model.

The boiler output boiler will never exceed the selected value.

The boiler will continue to modulate in heating mode on all the lower steps, adapting to the installation's consumption.

It is necessary to employ an external ambient thermostat or a chrono thermostat.

The output in S.H.W. on the CMX15 and CMX18 models is also limited to the maximum value of the corresponding table.

To access the electronic card, disconnect the boiler from the mains and remove the front panel.

Removing the upper screws, tilt the control panel. Locate the main card.



*Location of electronic card.*

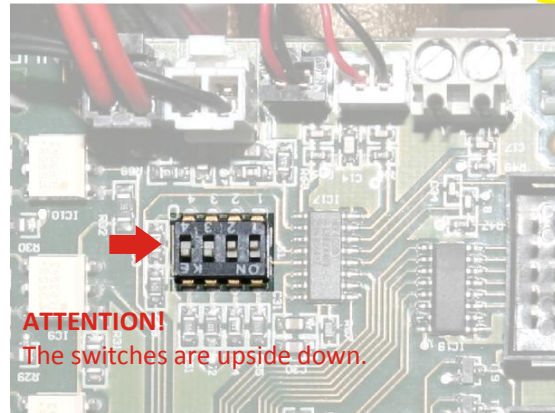

*Location of the switches.*







Move the switches with a small screwdriver and make them coincide with the corresponding combination on the tables for each boiler model.

Replace the front panel following the steps in reverse and connect the boiler to the mains.







**IMPORTANT:** Check immediately before activating the modulation system with a hook-on meter that the consumption corresponds to the output selected.

On the CMX models, turn off the S.H.W. pressing the  button to verify the heating consumption.

## LIMITATION OF OUTPUT ON MODELS CM18 & CMX18













POSITION OF THE SWITCHES	MAXIMUM OUTPUT LIMITED TO :	MAX. CURRENT PHASE R :	MAX. CURRENT PHASE S :	MAX. CURRENT PHASE T :
	<b>18kW</b>	26.0A	26.0A	26.0A
	<b>15kW</b>	13.0A	26.0A	26.0A
	<b>12kW</b>	13.0A	13.0A	26.0A
	<b>9kW</b>	13.0A	13.0A	13.0A
	<b>6kW</b>	-	13.0A	13.0A
	<b>3kW</b>	-	-	13.0A

Connection 3x400V~+N













POSITION OF THE SWITCHES	MAXIMUM OUTPUT LIMITED TO :	MAX. CURRENT
	<b>18kW</b>	78.3A
	<b>15kW</b>	65.2A
	<b>12kW</b>	52.2A
	<b>9kW</b>	39.1A
	<b>6kW</b>	26.1A
	<b>3kW</b>	13.0A

Connection 230V~

## LIMITATION OF OUTPUT ON MODELS CM15 & CMX15

POSITION OF THE SWITCHES	MAXIMUM OUTPUT LIMITED TO :	MAX. CURRENT PHASE R :	MAX. CURRENT PHASE S :	MAX. CURRENT PHASE T :
	<b>15kW</b>	21.7A	21.7A	21.7A
	<b>13kW</b>	13.0A	21.7A	21.7A
	<b>12kW</b>	21.7A	21.7A	8.7A
	<b>11kW</b>	13.0A	13.0A	21.7A
	<b>10kW</b>	21.7A	8.7A	13.0A
	<b>9kW</b>	13.0A	13.0A	13.0A
	<b>8kW</b>	13.0A	8.7A	13.0A
	<b>7kW</b>	8.7A	13.0A	8.7A
	<b>6kW</b>	8.7A	8.7A	8.7A
	<b>5kW</b>	-	13.0A	8.7A
	<b>4kW</b>	8.7A	8.7A	-
	<b>3kW</b>	-	-	13.0A
	<b>2kW</b>	8.7A	-	-

Connection 3x400V~+N

POSITION OF THE SWITCHES S	MAXIMUM OUTPUT LIMITED TO :	MAX. CURRENT
	<b>15kW</b>	65.2A
	<b>13kW</b>	56.5A
	<b>12kW</b>	52.2A
	<b>11kW</b>	47.8A
	<b>10kW</b>	43.5A
	<b>9kW</b>	39.1A
	<b>8kW</b>	34.8A
	<b>7kW</b>	30.4A
	<b>6kW</b>	26.1A
	<b>5kW</b>	21.7A
	<b>4kW</b>	17.4A
	<b>3kW</b>	13.0A
	<b>2kW</b>	8.7A

Connection 230V~

It is possible to check the actual configuration of a boiler by pressing the  button for three seconds.

The heating display will show  followed by the value of the return probe of the heating circuit.

On pushing  button the display will show  followed by the value of the limited maximum output according to the preceding tables.

On pushing  button again the display will show  followed by the actual modulated output value.

## 5 DESCRIPTION OF THE CONTROL PANEL

MODELS CMX18 & CMX15

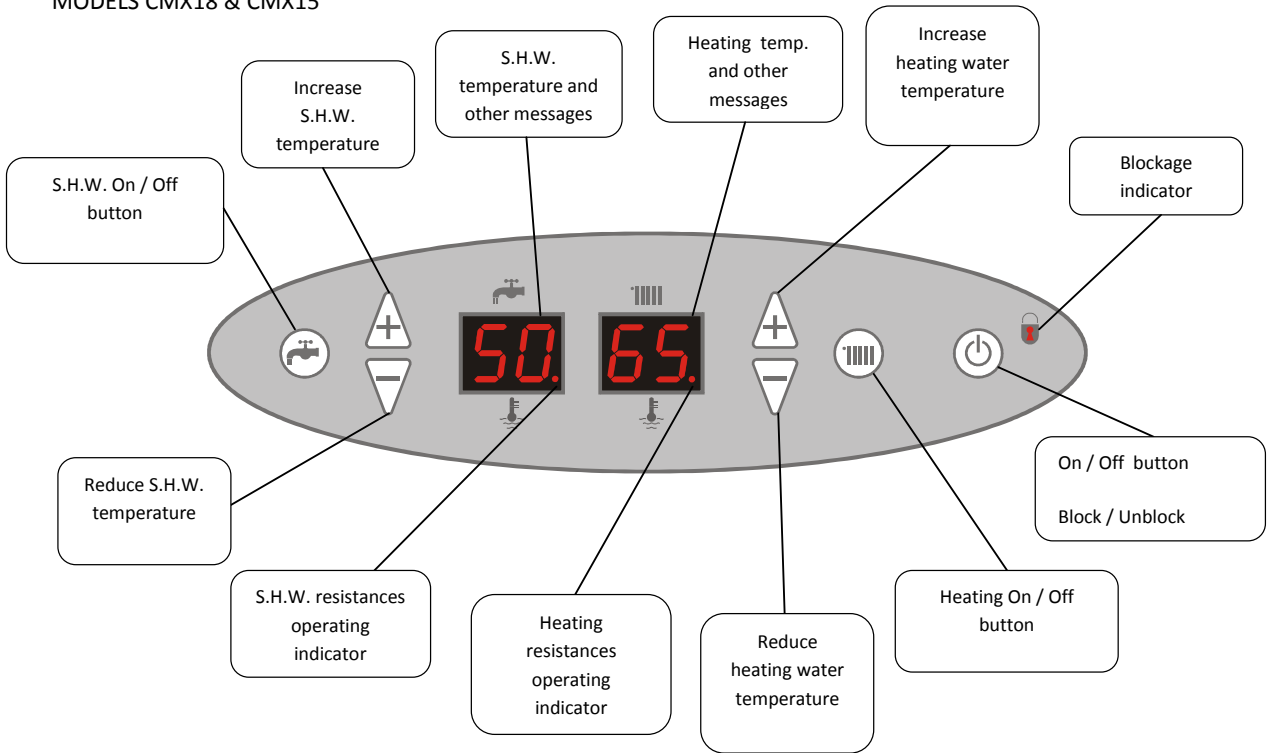

MODELS CM18 & CM15

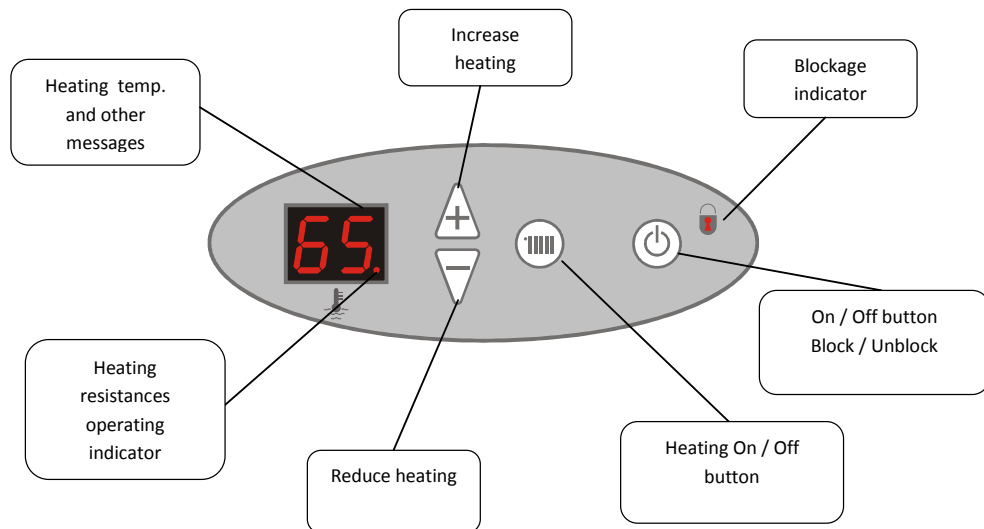



## 6 USING THE BOILER

### 6.1 TURNING ON AND OFF

When the boiler is connected to the mains it will perform a general self-check and, if any defect is detected, it will be indicated on the heating or S.H.W. displays.

Push the  button to start the boiler up. The same button will turn the boiler off when pushed again.

If the heating display only shows a small red dot, the heating function is switched off.

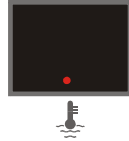



To start the heating, push the  button.

The same occurs with the Sanitary Hot Water (S.H.W.): if the display is off apart from a small red dot, the S.H.W.

function is switched off; to switch the S.H.W. on, press the  button.

### 6.2 BLOCKING THE CONTROLS

By keeping the  button pressed down for a few seconds, the padlock will light up .

The control buttons of the boiler will be blocked and no button will respond when pressed. Internally all the settings remain the same and the boiler functions normally.

To unblock the buttons, press the button down for a few seconds until the padlock light goes off. If the boiler is disconnected from the mains or there is a failure in the house's electricity supply, the buttons will also be unblocked.

### 6.3 HEATING



Always maintain an adequate pressure in the heating circuit. The water pressure gauge should mark about 1.5 bar. If the pressure rises above this, open the draining valve of the heating circuit located in the house slightly until the pressure reaches 1.5 bar when cold.

If the pressure is lower, open the filling valve of the heating circuit located under the boiler until the proper pressure is reached.

To start the heating, push the  button. At the end of the heating time, we can turn this function off by pressing the same button (the display will then only show a small red dot).

When the heating is on, the display will show the impulsion temperature of the water.



We can modify the setting of the impulsion temperature of the water by pushing either the  button or the  button and using the same buttons to adjust the value that flashes on the display.

The modified setting will be stored after a few seconds or instantly if we push the  button.

If the setting is higher than the actual temperature of the heating water and the S.H.W. is not connected, the heating will connect and a small red indicator of the consumption of heating resistances will light up.

This will always occur if the ambient temperature demands it.



The heating setting can be varied between 8 and 85°C. The symbol H appears after the 85 value or before the 8 value. If we select this value, the heating will function in anti-freeze mode: if the temperature falls below 7°C, the boiler will connect automatically.

### 6.3.1 AMBIENT THERMOSTAT

The optimum operation of the heating installation is achieved when an ambient thermostat or ambient chrono thermostat is connected to the boiler.

Connect the normally open contact of the ambient thermostat to the terminals of the electronic card of the boiler in substitution of the bridge.

### 6.3.2 MODULATION OF THE HEATING

Always provided that an ambient thermostat is connected to the boiler, this will work modulating the output, adjusting it to the heat necessities of the installation. In this way, on cold days the boiler will use more power and on warmer days the power consumed will be reduced.

This occurs automatically and requires no action on the part of the user; just follow the specific instructions of the ambient thermostat or chrono thermostat.

### 6.3.3 ANTI-BLOCKING OF THE ACCELERATOR PUMP

The boiler has a blocking control on the circulation pump. Whenever the heating is turned off, the circulation pump continues working for two minutes more.

Whenever the boiler is started using  button the pump will run for 10 seconds even though the heating is switched off.

Once every month, even if the boiler or the heating is switched off, the pump will run for 10 seconds.



If, despite everything, the pump seizes, follow the following steps in order to unblock it:

- First disconnect the boiler from the mains.
- Take off the front panel after removing the two screws on the upper part of the boiler to access the pump.
- Remove the front cover as shown in the figure. A small quantity of water may appear at this moment, stop it from splashing by using a cloth or absorbent paper.
- Using a suitable screwdriver, turn the shaft several times until it moves smoothly.
- Replace the cover and the front panel with the screws.

#### 6.3.4 HEATER SAFETY

##### FLOW FAILURE

If the error E3 appears on the display, the boiler has detected a flow failure in the heating circuit.



The possible causes of this error are:

- A blocked pump.
- All the thermostat valves are closed and there is no circuit that permits the water return.
- The circuit pressure is insufficient.
- The heating circuit is blocked.

After solving the cause of the error, the boiler must be turned off and re-started to eliminate the display message.

##### HEATER OVERHEATING

If the error E4 appears on the display, the boiler has detected overheating in the heating circuit.



Once the cause of the overheating has been eliminated, the thermal limiter must be re-armed.

To do so, unscrew the black cap and push the small pin behind it until you hear a click.

The limiter will not re-arm until the temperature in the heating header goes below 100°C or 80°C if the boiler is adapted for radiant floor heating.

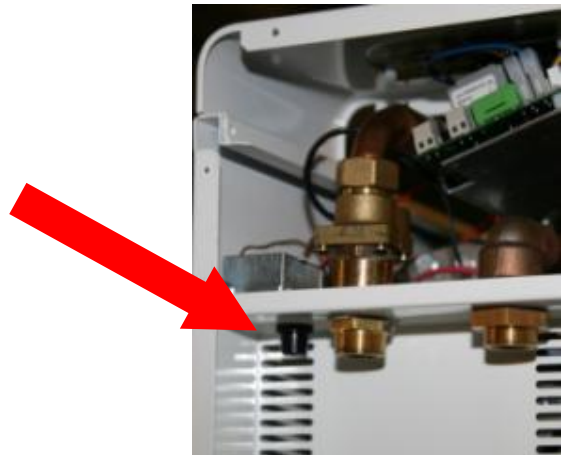

##### HEATING SAFETY VALVE

A safety valve set at 3 kg/cm<sup>2</sup> will activate if the pressure of the heating circuit passes said value, expelling water. It is essential that this valve runs to a drain.

## 6.4 SANITARY HOT WATER (S.H.W.)

The CMX15 and CMX18 boilers have a mixed function of modulated heating and the preparation of sanitary hot water. The S.H.W. function has priority over the heating and so the outputs are never added together.



A 50-litre header tank lagged with CFC free insulation accumulates the sanitary hot water.

### 6.4.1 AJUSTING THE S.H.W. TEMPERATURE

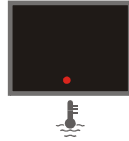
To switch on the S.H.W. push the  button. This function can be switched off by pushing the same button (the display will only show a small red dot).



When the S.H.W. is switched on, the display will show the actual temperature in the S.H.W. accumulation tank.

The setting of the S.H.W. temperature can be modified by pushing both the  button or the  button and adjusting the setting that flashes on the display. The modified setting will be stored automatically after a few seconds, or instantly if we push the  button.

The S.H.W. setting can be varied between 20 and 55°C.

### 6.4.2 SANITARY HOT WATER SAFETY

#### OVERHEATING OF THE S.H.W.

If the error E7 appears on the display, the boiler has detected the overheating in the sanitary hot water tank.



Once the cause of the overheating has been eliminated, the thermal limiter of the S.H.W. must be re-armed.

To do so, unscrew the black cap and push the small pin behind it until you hear a click.

The limiter will not re-arm until the temperature in the S.H.W. header tank has gone down to below 80°C.

#### S.H.W. SAFETY VALVE

A safety valve set at 7 kg/cm<sup>2</sup> will activate if the pressure in the S.H.W. accumulator tank exceeds said value, expelling water. It is essential that this valve runs to a drain.

#### S.H.W. RETENTION VALVE

This prevents the S.H.W. accumulator tank from emptying even when the water supply to the dwelling is cut off.

## 7 MAINTENANCE

Gabarrón electric boilers do not need any special maintenance, only the following should be checked:

- Check the pressure indicated by the pressure gauge frequently, ensuring that it is between 1 and 1.5 bar when cold.
- Never start the boiler when it is empty.
- Never start the boiler when the S.H.W. tank is empty; to fill it for the first time open a hot water tap and wait until water comes out of it.

-Precaution against freezing. In dwellings that are frequently unoccupied or at risk of freezing, an anti-freeze of the appropriate quality can be added to the water of the heating installation – the concentration must not exceed 30% in volume.

- Clean the surfaces of the boiler with a damp cloth, having previously disconnected it from the mains. Do not use solvents or abrasive products.

## 8 TROUBLESHOOTING

Problem	Possible cause	Solution
Boiler will not start	No current entering boiler.	Check the installation.
Error E1	Heating water out temperature probe defective.	Contact Technical Service
Error E2	Heating water return temperature probe defective.	Contact Technical Service
Error E3 Lack of heating water flow.	Pump blocked.	Unblock – see instructions
	Valves shut.	Open valves.
	Air in the installation.	Purge the installation
Error E4 Overheating of the heating.	Pump blocked.	Unblock – see Section 6.3.3.
	Valves shut.	Open valves.
	Air in the installation.	Purge the installation.
Error E5	Configuration error of the maximum limited output.	See Section 5 LIMITATION OF OUTPUT
Error E6	S.H.W. temperature probe defective.	Contact Technical Service
Error E7 Overheating of S.H.W.	S.H.W. tank empty.	Open a hot water tap until the water flows. See Section 6.4.2 S.H.W. Safety.
Heating safety valve expels water	Excessive pressure in cold.	Adjust to between 1 & 1.5bar.
	Expansion vessel breakdown.	Change.
	Water entering heating circuit.	Check filling valve.
S.H.W. safety valve expels water.	Entering water pressure too high.	Install a pressure reducer.
	S.H.W. expansion vessel breakdown	Change.
The buttons do not respond	Control panel blocked	See Section 10.2 BLOCKING THE CONTROLS
Low temperature in the installation.	Heating setting low.	Regulate.
	Setting of ambient thermostat low.	Regulate.
	Resistances broken down.	Contact Technical Service.
	Badly calculated installation.	Increase output.

After resolving the problem, in order to eliminate the error message on the display, it is necessary to switch the

boiler off and on using the  button.

9 TECHNICAL DATA		CMX15	CMX18	CM15	CM18
Frequency	Hz	50	50	50	50
<b>Connection 3x400V+N~</b>		◆	◆	◆	◆
Output limited to <b>18kW</b> ; Maximum intensity	A	-	26.0	-	26.0
Output limited to <b>15kW</b> ; Maximum intensity	A	21.7	26.0	21.7	26.0
Output limited to <b>13kW</b> ; Maximum intensity	A	21.7	-	21.7	-
Output limited to <b>12kW</b> ; Maximum intensity	A	21.7	26.0	21.7	26.0
Output limited to <b>11kW</b> ; Maximum intensity	A	21.7	-	21.7	-
Output limited to <b>10kW</b> ; Maximum intensity	A	21.7	-	21.7	-
Output limited to <b>9kW</b> ; Maximum intensity	A	13.0	13.0	13.0	13.0
Output limited to <b>8kW</b> ; Maximum intensity	A	13.0	-	13.0	-
Output limited to <b>7kW</b> ; Maximum intensity	A	13.0	-	13.0	-
Output limited to <b>6kW</b> ; Maximum intensity	A	8.7	13.0	8.7	13.0
Output limited to <b>5kW</b> ; Maximum intensity	A	13.0	-	13.0	-
Output limited to <b>4kW</b> ; Maximum intensity	A	8.7	-	8.7	-
Output limited to <b>3kW</b> ; Maximum intensity	A	13.0	13.0	13.0	13.0
<b>Connection 230V~ single phase</b>		◆ <sup>1</sup>	◆ <sup>1</sup>	◆ <sup>1</sup>	◆ <sup>1</sup>
Nominal maximum intensity <b>18kW</b>	A	-	78.3	-	78.3
Nominal maximum intensity <b>15kW</b>	A	65.2	65.2	65.2	65.2
Maximum converted intensity at <b>13kW</b>	A	56.5	-	56.5	-
Maximum converted intensity at <b>12kW</b>	A	52.2	52.2	52.2	52.2
Maximum converted intensity at <b>11kW</b>	A	47.8	-	47.8	-
Maximum converted intensity at <b>10kW</b>	A	43.5	-	43.5	-
Maximum converted intensity at <b>9kW</b>	A	39.1	39.1	39.1	39.1
Maximum converted intensity at <b>8kW</b>	A	34.8	-	34.8	-
Maximum converted intensity at <b>7kW</b>	A	30.4	-	30.4	-
Maximum converted intensity at <b>6kW</b>	A	26.1	26.1	26.1	26.1
Maximum converted intensity at <b>5kW</b>	A	21.7	-	21.7	-
Maximum converted intensity at <b>4kW</b>	A	17.4	-	17.4	-
Maximum converted intensity at <b>3kW</b>	A	13.0	13.0	13.0	13.0
S.H.W. available time with <b>15kW</b>	min	5'49"	5'49"	-	-
S.H.W. available time with <b>13kW</b>	min	6'42"	-	-	-
S.H.W. available time with <b>12kW</b>	min	7'16"	7'16"	-	-
S.H.W. available time with <b>11kW</b>	min	7'56"	-	-	-
S.H.W. available time with <b>10kW</b>	min	8'43"	-	-	-
S.H.W. available time with <b>9kW</b>	min	9'41"	9'41"	-	-
S.H.W. available time with <b>8kW</b>	min	10'54"	-	-	-
S.H.W. available time with <b>7kW</b>	min	12'27"	-	-	-
S.H.W. available time with <b>6kW</b>	min	14'32"	14'32"	-	-
S.H.W. available time with <b>5kW</b>	min	17'26"	-	-	-
S.H.W. available time with <b>4kW</b>	min	21'48"	-	-	-
S.H.W. available time with <b>3kW</b>	min	29'04"	29'04"	-	-
S.H.W. available time with <b>2kW</b>	min	43'36"	-	-	-
Weight	kg	70	70	32	32
Insulated steel heater header		◆	◆	◆	◆
50 litre stainless steel insulated S.H.W. accumulator	No CFC	◆	◆	-	-
Stainless steel plated resistance elements INCOLOY800	S.H.W.	◆	◆	-	-
Stainless steel plated resistance elements INCOLOY800	Heating	◆	◆	◆	◆
6 litre expansion vessel		◆	◆	◆	◆
S.H.W. 2 litre expansion vessel		◆	◆	-	-
Electronic regulation of heater modulation		◆	◆	◆	◆
Electronic regulation S.H.W..		◆	◆	-	-
Digital display		◆	◆	◆	◆
0-4 kg/cm <sup>2</sup> pressure gauge		◆	◆	◆	◆
Accelerator pump		◆	◆	◆	◆
Automatic purge		◆	◆	◆	◆
TRIACS silent power switches		◆	◆	◆	◆
Heating flow detector		◆	◆	◆	◆
S.H.W. flow detector.		◆	◆	-	-
100°C heating temperature limiter		◆	◆	◆	◆
80°C S.H.W. temperature limiter		◆	◆	-	-
3kg/cm <sup>2</sup> heating safety valve		◆	◆	◆	◆
7kg/cm <sup>2</sup> S.H.W. safety valve		◆	◆	-	-
S.H.W. retention valve		◆	◆	-	-
Heating circuit entry valve and filling valve		◆	◆	-	-
Ambient thermostat intake		◆	◆	◆	◆

Anti-electrolysis S.H.W. hoses.  
◆included <sup>1</sup> using connecting bridge included



## 10 ENVIRONMENTAL INFORMATION

Gabarrón boilers are manufactured within a certified environmental management system. From the design stage, all the production phases are performed taking into account the most rigorous environmental requirements. For example, the selection of materials involves guaranteeing their biodegradability, re-use and recycling.

When this boiler's long, useful life is over; it must be handed in to an electrical equipment collection point for proper recycling. By ensuring that this product is correctly disposed of, you will help to avoid any possible negative effects on the environment and public health that could occur if this product is not properly handled. To obtain more detailed information on the recycling of this product, contact your local authority, your waste disposal service or the shop where you purchased the product.

These regulations only apply in EU member countries.

## 11 MAIN COMPONENTS

- Heating expansion vessel	ref. 60091510
- S.H.W. expansion vessel.	ref. 60091515
- S.H.W. expansion vessel hose.	ref.60100020
- 50 L S.H.W. insulated tank	ref. 60100072
- Insulated heating header tank.	ref. 60101300
- Circulation pump 25-40 (130).	ref. 60190070
- Circulation pump 25-60 (130)	ref. 60190071
- Main electronic card with support.	ref. 60101310
- S.H.W. electronic card with support.	ref. 60101320
- Controls card CM15 & CM18 with LEXAN.	ref. 60101330
- Controls card CMX15 & CMX18 with LEXAN.	ref. 60101340
- Temperature probe, white connector.	ref. 60100580
- Temperature probe, black connector.	ref. 60100590
- 15 kW heating resistance, inc. joint 140.	ref. 60100750
- 18 kW heating resistance, inc. joint 140.	ref. 60100760
- 15 kW S.H.W. resistance & S.H.W. joint	ref. 60100700
- S.H.W. resistance joint.	ref. 60101350
- ¾" heating flow detector.	ref. 60100800
- ½" S.H.W. flow detector.	ref. 60100810
- 0-4 bar pressure gauge.	ref. 60100820
- 100°C thermal limiter.	ref. 60091140
- 80°C thermal limiter.	ref. 60091150
- Automatic purge.	ref. 60091280
- 3kg/cm <sup>2</sup> heating valve.	ref. 60091490
- 7kg/cm <sup>2</sup> S.H.W. valve.	ref. 60091500
- S.H.W. retention valve.	ref. 60091501
- ½" filling / shut off valve.	ref. 60091160



## 12 WIRING

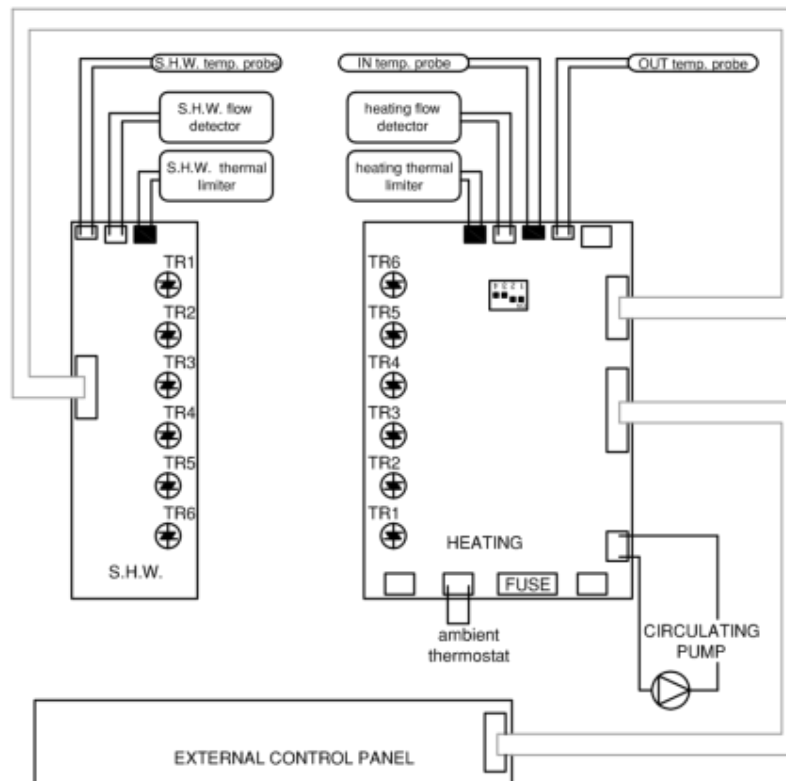
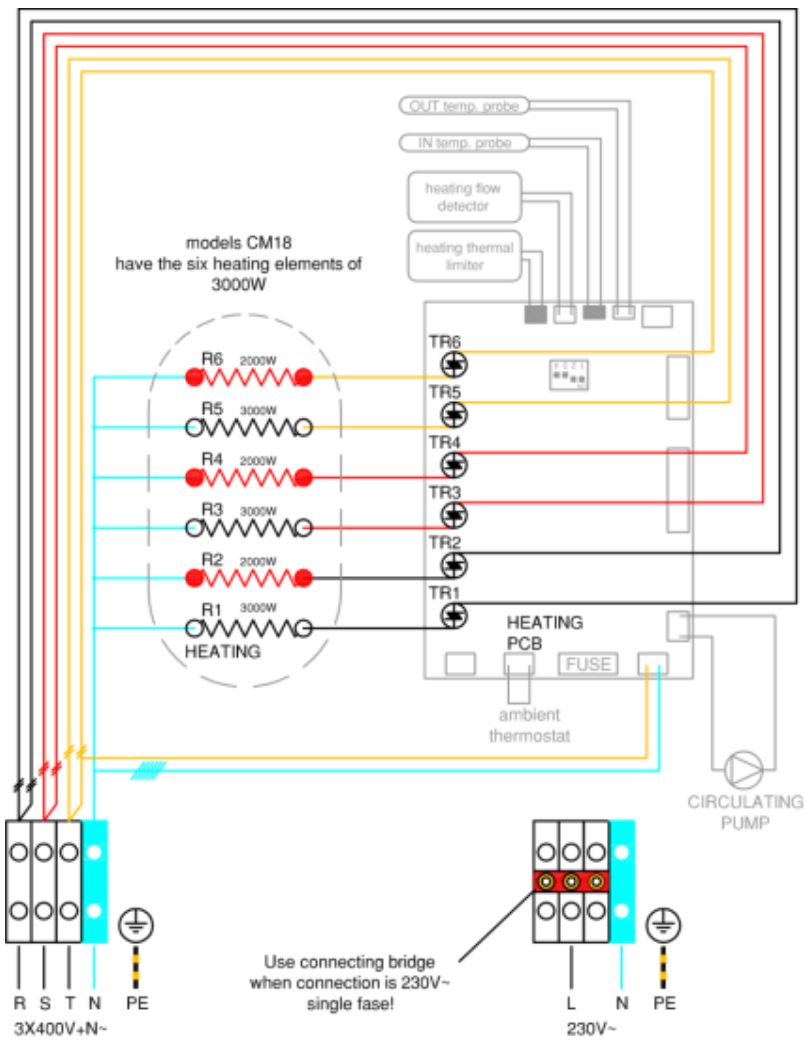

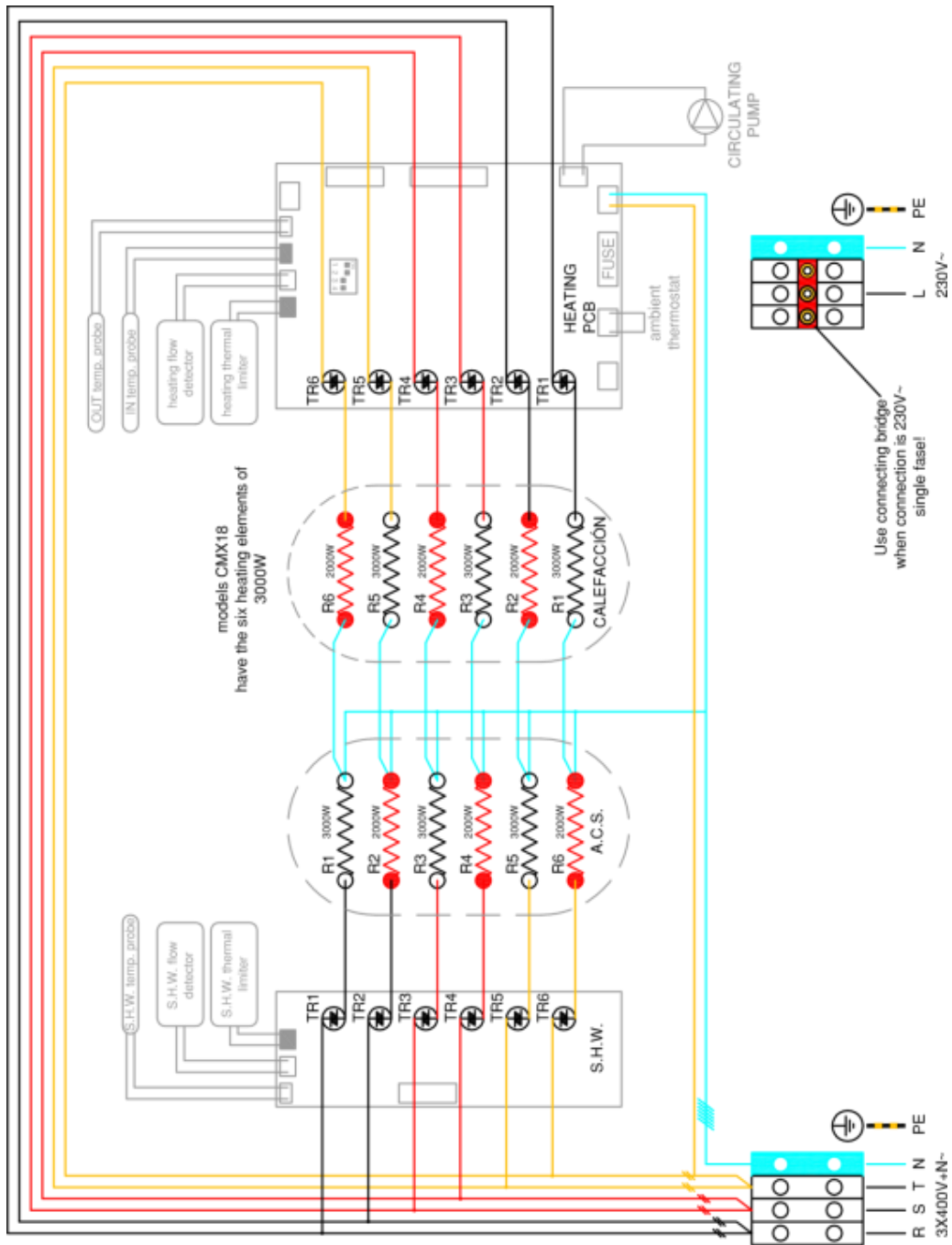



[www.elnur.es](http://www.elnur.es)

Fabricado por:  
Manufactured by:

ELNUR s.a.  
Pol. Ind. "El Nogal" Villa Esther, 11  
28110, ALGETE - Madrid

Departamento de atención al cliente:  
Customer Service Department:

**+34 902 19 57 14**



*Como parte de la política de mejora continua, Elnur s.a. se reserva el derecho a realizar modificaciones técnicas sin previo aviso.*

*As a part of the policy of continuous product improvement, Elnur s.a reserves the right to alter specifications without notice.*

